



无菌中硼硅玻璃管制注射剂瓶产品说明

Product Specification for Sterile injection vials made of middle borosilicate glass tubing

产品名称 Product Name	无菌中硼硅玻璃管制注射剂瓶 Sterile injection vials made of middle borosilicate glass tubing	标称容量 Nominal Capacity	50ml
文件编号 Document Code	PS-X-19	版本号 Version	02

文件批准 Document Approval

	部门 Department	姓名 Name	签字 Signature	日期 Date
起草人 Prepared by	研发部 Research and Development Department	赵自强		
审核人 Reviewed by	研发部 Research and Development Department	张鑫		
批准人 Approved by	质量部 Quality Department	孟壮		

文件批准（客户） Document Approval (Customer)

	部门 Department	签字 Signature	日期 Date
审核人 Reviewed by			
审核人 Reviewed by			
批准人 Approved by			

生产地址：四川省成都市双流区岐黄一路 1000 号天府国际生物产业加速器二期
Production address: No. 1000, Qihuang 1st Road, Shuangliu District, Chengdu, Sichuan Province
联系电话 TEL: 028-83588782-8008
Http: // www.tofflon.com

目录 contents

1. 范围 Scope	2
2. 产品描述 Components Description	2
3. 包装规范 Packing Specifications	3
3.1. 初级包装 Primary packaging	3
3.2. 次级包装 Secondary Packaging	4
4. 产品包装、标识和储存 Packaging, Labelling, Storage	5
5. 产品符合性 Product Conformity	6
6. 质量保证 Quality Assurance	6
7. 修订历史 History	9
8. 附件 Drawing	9
8.1. 附件一：玻璃西林瓶 50ml Drawing 1: Glass vial 50ml	9
8.2. 附件二：西林瓶托盘 50ml Drawing 2: TRAY 50ml	9
8.3. 附件三：产品装箱示意图 Drawing 3: Box packaging	9
8.4. 附件四：产品堆码示意图 Drawing 4: Pallet stacking	9

1. 范围 Scope

本文件适用于四川东富龙药用包装材料有限公司（以下简称东富龙）托盘包装的 50ml 无菌中硼硅玻璃管制注射剂瓶（简称玻璃西林瓶）。

This document applies to 50ml sterile injection vials made of middle borosilicate glass tubing (referred to as glass vials) in trays manufactured by Sichuan Tofflon Pharmaceutical Packaging Co., Ltd.

无菌中硼硅玻璃管制注射剂瓶为一次性使用、免洗免灭菌、无热原的注射剂用包装材料。

Sterile injection vials made of middle borosilicate glass tubing are single-use, Ready to Use, and non-pyrogen packaging materials for injections.

无菌中硼硅玻璃管制注射剂瓶的灌装和密封过程由制剂企业完成，相关研究由制剂企业进行。

The filling and closure of the vial is not completed by Tofflon and is not Tofflon's responsibility.

2. 产品描述 Components Description

部件 Component	材料描述 Material Description	法规标准符合性 Regulatory Reference
玻璃西林瓶 Glass vial	中硼硅玻璃管制注射剂瓶 Injection vials made of middle borosilicate glass tubing	ISO 8362-1 YBB00292005-2-2015 ChP 9622 USP<660> EP 3.2.1
托盘 TRAY	聚丙烯（PP）	ISO 10993
Tyvek®盖材 Tyvek® Sheet	Tyvek®: PE-HD 纤维 Tyvek®: PE-HD fibbers	ISO 10993-5
Tyvek®封纸 Tyvek® Lid	Tyvek®: PE-HD 纤维, 涂胶 Tyvek®: PE-HD fibbers and adhesive	ISO 10993-5
灭菌袋 Steribag	双袋: 低密度聚乙烯(LDPE)与 Tyvek® Double bags: LDPE bag with Tyvek® window	ISO 10993-5
灭菌 Sterilization	环氧乙烷灭菌 EtO Sterilization	GB 18279 ISO 11135

3. 包装规范 Packing Specifications

3.1. 初级包装 Primary packaging

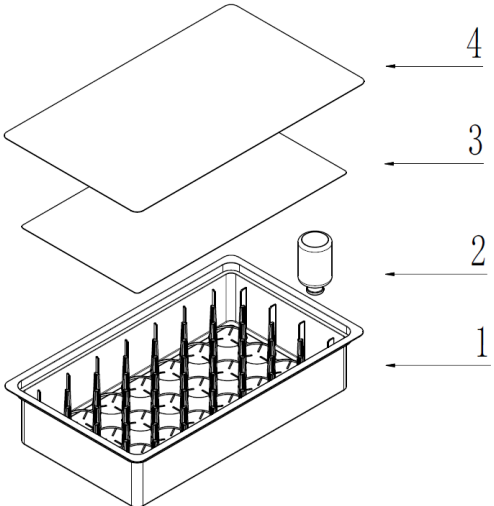
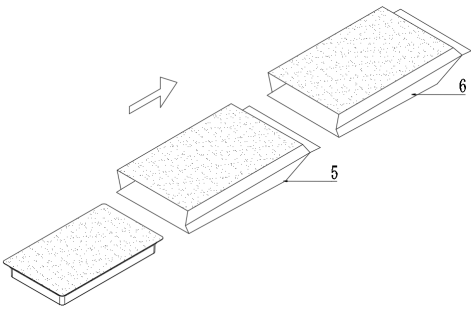
托盘 TRAY			
	序号 ID	描述 Description	备注 Note
	1	托盘 TRAY	见附件二 Drawing 2
	2	玻璃西林瓶 Glass vial	见附件一 Drawing 1
	3	Tyvek®盖材 Tyvek® Sheet	-
	4	Tyvek®封纸 Tyvek® Lid	-
	技术参数 Technical Parameters		
	每托盘产品数量 (个) Vials / TRAY		28
每托盘产品重量 (g) Gross Weight		1330	
双层灭菌袋包装 Double Steribags packaging			
	序号 ID	描述 Description	备注 Note
	5	第一个灭菌袋 1st Steribag	-
	6	第二个灭菌袋 2nd Steribag	-

3.2. 次级包装 Secondary Packaging

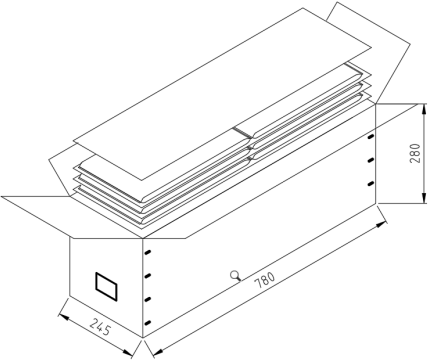
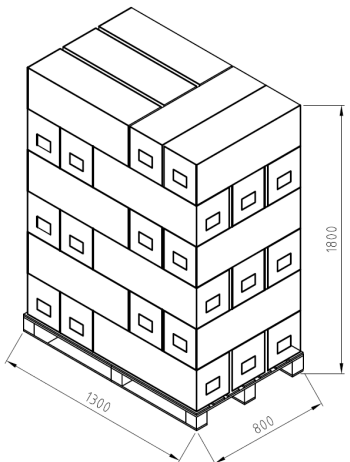
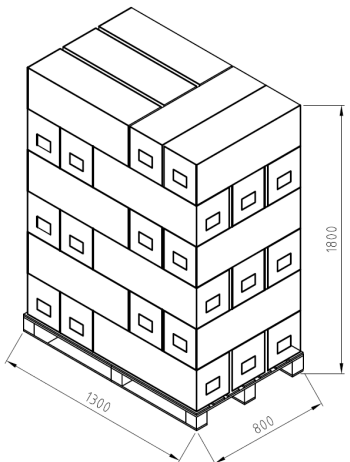
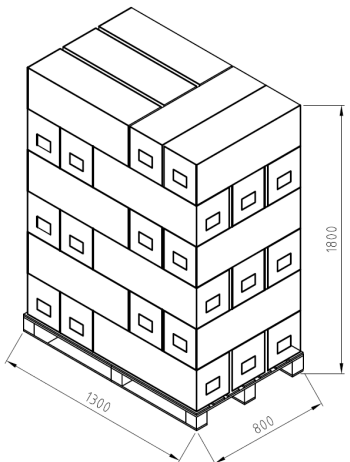
纸箱包装 Box packaging																				
	技术参数 Technical parameters																			
	纸箱尺寸 (长*宽*高 (mm)) Overall dimension (length*width*height) (mm)	780 * 245 * 280																		
	每层的托盘数量 (盒) Tubs per layer (pcs)	2																		
	每箱的层数 (层) Layers per box (pcs)	3																		
	托盘总数 (盒) Tubs per box (pcs)	6																		
	瓶子总数 (只) Total quantity of vials per box (pcs)	168																		
	每箱重量 (kg) Gross weight (kg)	9.9																		
	<table border="1"> <thead> <tr> <th colspan="3">纸箱包装 Box packaging</th> </tr> </thead> <tbody> <tr> <td rowspan="8">  </td> <td colspan="2">技术参数 Technical parameters</td> </tr> <tr> <td>运输装载尺寸 (长*宽*高 (mm)) Pallet dimension (length*width*height) (mm)</td> <td>1300 * 800 * 1800</td> </tr> <tr> <td>每层的包装纸箱数量 (箱) Boxes per layer (pcs)</td> <td>5</td> </tr> <tr> <td>每托盘层数 (层) Layers per pallet (pcs)</td> <td>6</td> </tr> <tr> <td>包装纸箱总数 (箱) Boxes per pallet (pcs)</td> <td>30</td> </tr> <tr> <td>产品总数 (只) Vials per pallet (pcs)</td> <td>5040</td> </tr> <tr> <td>每托盘重量 (kg) Gross Weight (kg)</td> <td>311</td> </tr> </tbody> </table>			纸箱包装 Box packaging				技术参数 Technical parameters		运输装载尺寸 (长*宽*高 (mm)) Pallet dimension (length*width*height) (mm)	1300 * 800 * 1800	每层的包装纸箱数量 (箱) Boxes per layer (pcs)	5	每托盘层数 (层) Layers per pallet (pcs)	6	包装纸箱总数 (箱) Boxes per pallet (pcs)	30	产品总数 (只) Vials per pallet (pcs)	5040	每托盘重量 (kg) Gross Weight (kg)
纸箱包装 Box packaging																				
	技术参数 Technical parameters																			
	运输装载尺寸 (长*宽*高 (mm)) Pallet dimension (length*width*height) (mm)	1300 * 800 * 1800																		
	每层的包装纸箱数量 (箱) Boxes per layer (pcs)	5																		
	每托盘层数 (层) Layers per pallet (pcs)	6																		
	包装纸箱总数 (箱) Boxes per pallet (pcs)	30																		
	产品总数 (只) Vials per pallet (pcs)	5040																		
	每托盘重量 (kg) Gross Weight (kg)	311																		
	产品装箱和堆码示意图见附件三、附件四 The drawings of product box packaging and pallet packaging are shown in Drawing 3 and Drawing 4.																			

4. 产品包装、标识和储存 Packaging, Labelling, Storage

为保护产品免受污染和损害，本产品经清洗烘干后，采用托盘及双层灭菌袋包装，并在 C 级背景下的 A 级洁净环境中内包装。托盘、封纸和双层灭菌袋形成无菌屏障系统。内包装完成后，产品装入五层瓦楞纸箱，每层产品之间均安装隔板，产品托盘堆码完成后，各边角均采用缠绕膜保护，从而更好地确保产品在运输和储存过程不发生破坏和污染。

To protect the product from contamination and damage, this product is packaged in trays and double steribags, and the process after washing and drying are carried out in Class A clean environment in Class C background. Tray, Tyvek Lid, and steribag form the sterile barrier system. After the primary packaging, the product is loaded into a five-layer corrugated box, and after the product pallet is stacked, all corners are protected by stretch film, so as to better ensure that the product is not damaged and polluted during transportation and storage.

本产品标识信息如下：Packaging identification may include the following information:

标识信息 Identification Information	灭菌袋 Steribag	纸箱 Box
供应商名称 Supplier Name	+	+
产品名称 Product Name	+	+
产品批号 Batch Number	+	+
产品数量 Quantity	+	+
生产日期 Manufacturing Date	+	+
有效期至 Expiry Date	+	+
灭菌方式 Type of sterilization	+	+

注：“+”表示标识该信息，“-”表示未标识该信息。

Note: "+" indicates that the information is identified, and "-" means that the information is not identified.

本产品应在室温下（10°C-30°C）储存。

This product should be stored at room temperature (10°C-30°C).

本产品为玻璃制品，通常不随时间老化，我公司按照 T/CNPPA 3017-2021《塑料和橡胶类药包材自身稳定性研究指南》对本产品的无菌屏障系统进行长期试验和加速试验，以评估其对产品的保护性随时间的变化，暂定本产品的有效期为 3 年。

This product is a glass product, usually does not age with time, Tofflon conducts long-term tests and accelerated tests to evaluate the protection of sterile barrier system over time in accordance with T/CNPPA 3017-2021 "Plastic and Rubber Pharmaceutical Packaging Materials Self Stability Research Guidelines". The shelf life of this product is tentatively set at 3 years.

5. 产品符合性 Product Conformity

我公司按照中国药典指导原则 9622、YBB00292005-2-2015、ISO 8362-1、USP<660>和 EP 3.2.1 等设定本产品质量标准并进行检验放行。

Tofflon sets the product quality standards and inspects and releases the product in accordance with the guideline of the Chinese Pharmacopoeia 9622, YBB00292005-2-2015, ISO 8362-1, USP<660> and EP 3.2.1.

本产品相容性研究按照《化学药品注射剂与药用玻璃包装容器相容性研究技术指导原则（试行）》及 ICH Q3D 执行。

The compatibility study of this product is carried out in accordance with the "Technical Guidelines for the Compatibility Study of Chemical Injections and Pharmaceutical Glass Packaging Containers (Trial)" and ICH Q3D.

6. 质量保证 Quality Assurance

我公司按照《药品生产质量管理规范》、《药包材生产质量管理规范》和 ISO 15378 药包材质量管理体系要求等法规标准建立、保持并持续改进我公司的质量管理体系，以确保持续提供符合规定且质量稳定的产品和服务。

Tofflon establishes, maintains and continuously improves our quality management system in accordance with regulations and standards such as "Good Manufacturing Practice for Pharmaceutical Manufacturing", "Good Manufacturing Practice for Pharmaceutical Packaging Materials" and ISO 15378 *Primary packaging materials for medicinal products-Particular requirements for the application of ISO 9001:2015, with reference to good manufacturing practice(GMP)* to ensure that we continue to provide products and services that meet the requirements and have controllable quality.

本产品符合以下法规及标准要求：

This product complies with the following regulations and standards:

- 中国药典 9622 药品包装用玻璃材料和容器指导原则
- ChP 9622 Guideline on Glass Containers for Pharmaceutical Packaging;
- YBB00292005-2-2015 《中硼硅玻璃管制注射剂瓶》；
- YBB00292005-2-2015 Injection vials made of middle borosilicate glass tubing;
- ISO 8362-1 Injection containers and accessories-Part 1: Injection vials made of glass tubing.
- USP<660> Containers-Glass
- EP 3.2.1 Glass containers for pharmaceutical use

我公司采取以下措施，从设计上控制本产品质量：

Tofflon takes the following measures to control the quality of this product from the design:

- 采购已在上市药品中使用多年的原材料；
- Procurement of raw materials that have been used in marketed drugs for many years.
- 产品经清洗后，通过隧道烘箱进行烘干并去除热原；

- After the product is washed, it is dried in a tunnel oven and pyrogen is removed.
- 产品清洗烘干后的装巢盒至内包装工序在 C 级背景下的 A 级洁净环境中进行，最大限度地控制产品微粒、细菌内毒素和微生物污染；
- After drying process, the primary packaging is carried out in a Class A clean environment in Class C background, so as to control the product particles, bacterial endotoxins and microbial contamination to the greatest extent.
- 生产线上配置了在线外观检测装置，第一时间剔除不良品；
- The production line is equipped with an online appearance inspection device to reject defective products at the first time.
- 采用全自动运线，杜绝人为差错。
- Automatic transportation line is adopted to eliminate human error.

我公司按照中国药典《药包材检验规则指导原则》和 GB/T 2828 (idt: ISO 2859) 制定本产品检验项目的检验规则和质量水平，如下表。

Tofflon formulate the inspection rules and Acceptance Quality Limit of the product inspection items in accordance with the ChP "Guiding Principles for the Inspection Rules of Pharmaceutical Packaging Materials" and GB/T 2828 (idt. :ISO 2859), as shown in the following table.

检验项目 Items	接受标准 Acceptance criteria	缺陷等级 分类 Defect grade classification	是否批 检验 Batch inspection?	检验水 平 Inspection level	接收质量 限 (AQL)
外观 Appearance	应无色透明或棕色透明；表面应光洁、平整，不应有明显的玻璃缺陷；任何部位均不得有裂纹。 It should be colorless and transparent or brown and transparent; The surface should be smooth and flat, without obvious glass defects; No part shall have cracks.	随机性缺陷 A 类 Random Defect A	是 Yes	I	0.4
线热膨胀系数 Linear thermal expansion coefficient	$(3.5 \sim 6.1) \times 10^{-6} \text{K}^{-1} (20 \sim 300^{\circ}\text{C})$	系统性缺陷 Systemic Defect	是 Yes	N/A	N/A
三氧化二硼含量 Boron trioxide content	$\geq 8\%$	系统性缺陷 Systemic Defect	否 No	N/A	N/A
尺寸 Dimension	应符合产品图纸要求 Should comply with quality standard	随机性缺陷 A Random Defect A	是 Yes	S-2	0.4

检验项目 Items	接受标准 Acceptance criteria	缺陷等级 分类 Defect grade classification	是否批 检验 Batch inspection?	检验水 平 Inspection level	接收质量 限 (AQL)
121°C 玻璃颗粒耐水性 121°C glass particle water resistance	应符合 1 级 Should comply with Level 1	随机性缺陷 A Random Defect A	是 Yes	N/A	N/A
内表面耐水性 121°C glass particle water resistance	应符合 HC1 级 Should comply with Level 1	系统性缺陷 A Random Defect A	是 Yes	N/A	N/A
砷、锑、铅、镉浸出量 As, Sb, Pd and Cd leachable amounts	每升浸出液中砷不得过 0.1mg、锑不得过 0.7mg、铅不得过 1.0mg、镉不得过 0.25mg As NMT 0.1mg, Sb NMT 0.7mg, Pd NMT 1.0mg, Cd NMT 0.25mg	系统性缺陷 Systemic Defect	否 No	N/A	N/A
内应力 Internal stress	退火后的最大永久应力造成的光程差不得过 40nm/mm The optical path difference caused by the maximum permanent stress after annealing shall not exceed 40nm/mm	随机性缺陷 A 类 Random Defect A	是 Yes	S-2	0.4
遮光性 Obscurity	应符合产品质量标准规定 Should comply with quality standard	系统性缺陷 Systemic Defect	是 Yes	N/A	N/A
耐热性 Heat resistance	不得破裂 Do not break	随机性缺陷 A 类 Random Defect A	是 Yes	S-3	0.4
耐冷冻性 Freezing resistance	不得破裂 Do not break	随机性缺陷 A 类 Random Defect A	是 Yes	S-3	0.4
玻璃颗粒测试 Glass Grains Test	每克测试玻璃消耗的盐酸（0.02 摩尔/升）体积小于 0.1ml Volume of 0.02 M HCl per g of Test Glass should NMT 0.1ml	N/A	N/A	N/A	N/A
表面玻璃测试 Surface Glass Test	应该符合质量标准 Should comply with quality standard	N/A	N/A	N/A	N/A
砷浸出量 As leachable	≤0.1µg/g	N/A	N/A	N/A	N/A

检验项目 Items	接受标准 Acceptance criteria	缺陷等级 分类 Defect grade classification	是否批 检验 Batch inspection?	检验水 平 Inspection level	接收质量 限 (AQL)
环氧乙烷残 留量 Residual amount of ethylene oxide	≤5μg/个 ≤5μg/unit	随机性缺 陷 A 类 Random Defect A	是 Yes	N/A	N/A
不溶性微粒 Insoluble particles	≥10μm 的微粒: 不得过 100 粒/瓶; ≥25μm 的微粒: 不得过 10 粒/瓶 ≥10μm particle NMT 100 /vial ≥25μm particle NMT 10 /vial	随机性缺 陷 A 类 Random Defect A	是 Yes	N/A	N/A
细菌内毒素 BET	<0.25EU/ml	随机性缺 陷 A 类 Random Defect A	是	N/A	N/A
无菌 Sterility	应符合规定 Be compliance	随机性缺 陷 A 类 Random Defect A	是	N/A	N/A

7. 修订历史 History

版本号 Version	修订日期 Date	变更描述 Description
01	2024.07.09	新文件 New document
02	2025.08.05	增加英文版本 Add English translation

8. 附件 Drawing

- | | |
|----------------------|----------------------------|
| 8.1. 附件一: 玻璃西林瓶 50ml | Drawing 1: Glass vial 50ml |
| 8.2. 附件二: 西林瓶托盘 50ml | Drawing 2: TRAY 50ml |
| 8.3. 附件三: 产品装箱示意图 | Drawing 3: Box packaging |
| 8.4. 附件四: 产品堆码示意图 | Drawing 4: Pallet stacking |

版本	修订标记	修订说明	修订人	修订日期

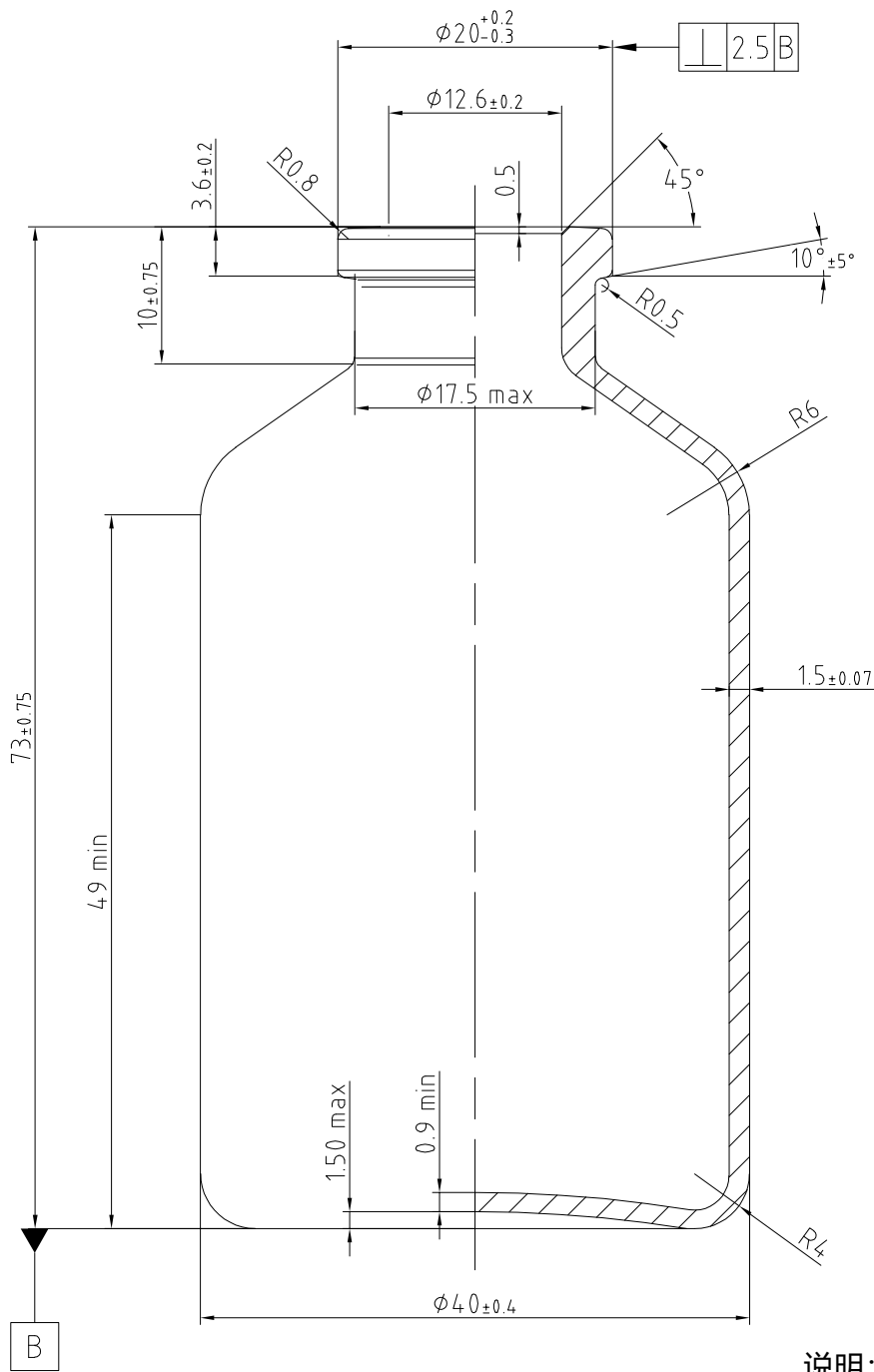

说明:

1. 符合标准: ISO 8362-1

Tofflon 东富龙

此图纸版权属于东富龙所有, 对未经许可擅自拷贝、使用者, 本公司保留追究其法律责任的权利。
THIS DRAWING IS COPYRIGHT. IT MUST NOT BE COPIED, REPRODUCED OR OTHERWISE MADE USE OF
WITHOUT THE TOFFLON'S WRITTEN PERMISSION.

标题/TITLE:

管制玻璃注射瓶 50R

页/SHEET: 1

共/OF: 1

图幅/SIZE: A4_CN

图号/DWG:

TZ-TFL-1074-01

版本/REV:

01

客户名/CUSTOMER:

项目号/PROJECT NUMBER:

设计/DESIGNED: Wanglei

日期/DATE: 2023.09.08

质量/MASS:

未注明公差表
TOLERANCED UNLESS OTHERWISE NOTED

校核/CHECKED: SQ

日期/DATE: 2023.09.08

比例/SCALE: 2:1



MACHINING
机加工

WELDING
焊接

SHEET METAL
钣金

审核/APPROVED: ZJW

日期/DATE: 2023.09.08

材料/MATERIAL: GLASS

GB/T 1804-m
GB/T 1184-K

GB/T 19804-B
GB/T 19804-F

GB/T 15055-m

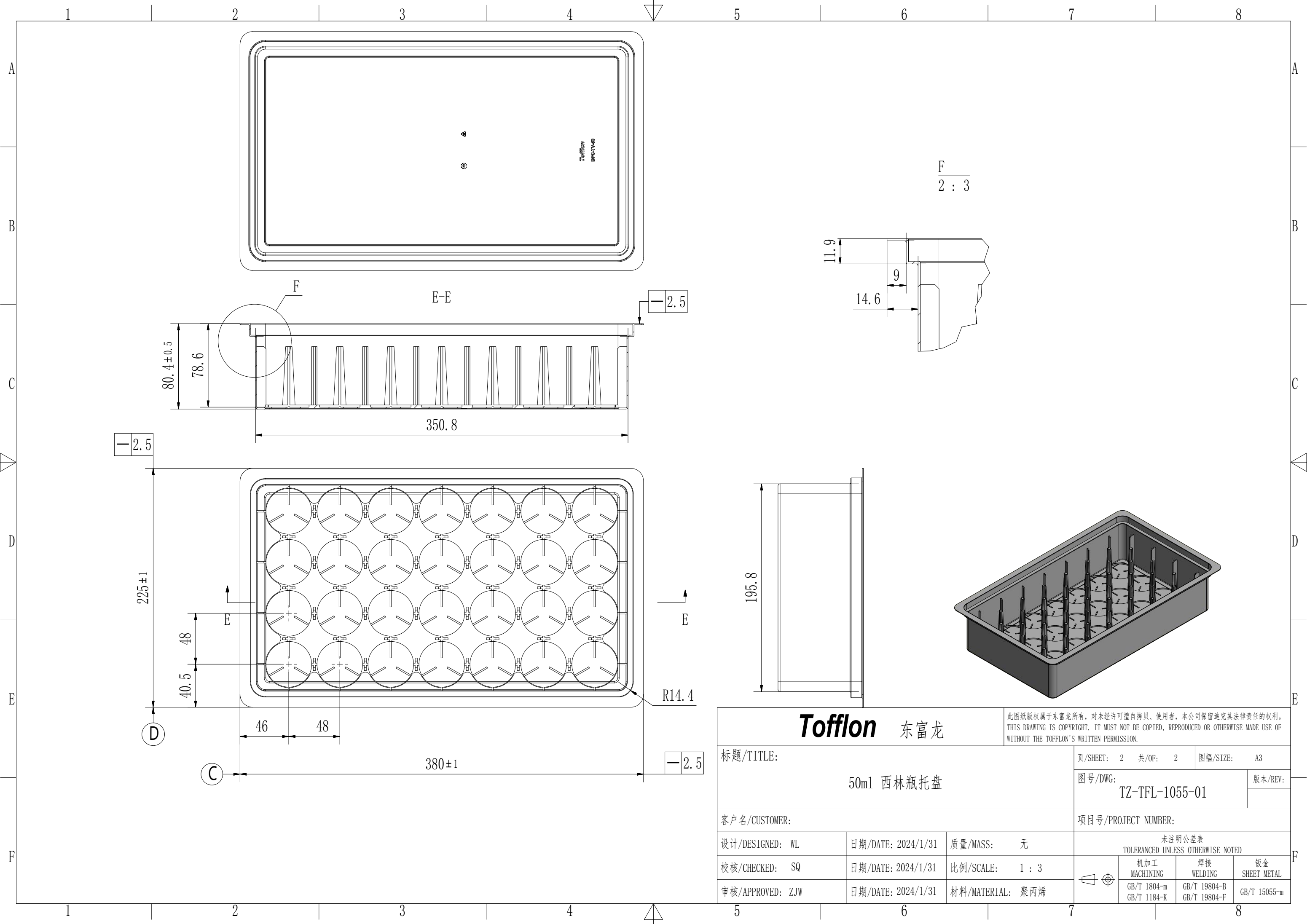

Tofflon 东富龙		此图纸版权属于东富龙所有，对未经许可擅自拷贝、使用者，本公司保留追究其法律责任的权利。 THIS DRAWING IS COPYRIGHT. IT MUST NOT BE COPIED, REPRODUCED OR OTHERWISE MADE USE OF WITHOUT THE TOFFLON'S WRITTEN PERMISSION.							
标题/TITLE:		页/SHEET: 2 共/OF: 2	图幅/SIZE: A3						
50ml 西林瓶托盘		图号/DWG: TZ-TFL-1055-01	版本/REV:						
客户名/CUSTOMER:		项目号/PROJECT NUMBER:							
设计/DESIGNED: WL	日期/DATE: 2024/1/31	质量/MASS: 无	未注明公差表 TOLERANCED UNLESS OTHERWISE NOTED						
校核/CHECKED: SQ	日期/DATE: 2024/1/31	比例/SCALE: 1 : 3							
审核/APPROVED: ZJW	日期/DATE: 2024/1/31	材料/MATERIAL: 聚丙烯	<table border="1" style="width: 100%;"> <tr> <td style="text-align: center;">机加工 MACHINING</td> <td style="text-align: center;">焊接 WELDING</td> <td style="text-align: center;">钣金 SHEET METAL</td> </tr> <tr> <td>GB/T 1804-m GB/T 1184-K</td> <td>GB/T 19804-B GB/T 19804-F</td> <td>GB/T 15055-m</td> </tr> </table>	机加工 MACHINING	焊接 WELDING	钣金 SHEET METAL	GB/T 1804-m GB/T 1184-K	GB/T 19804-B GB/T 19804-F	GB/T 15055-m
机加工 MACHINING	焊接 WELDING	钣金 SHEET METAL							
GB/T 1804-m GB/T 1184-K	GB/T 19804-B GB/T 19804-F	GB/T 15055-m							

1	2	3	4
版本	修订标记	修订说明	修订人

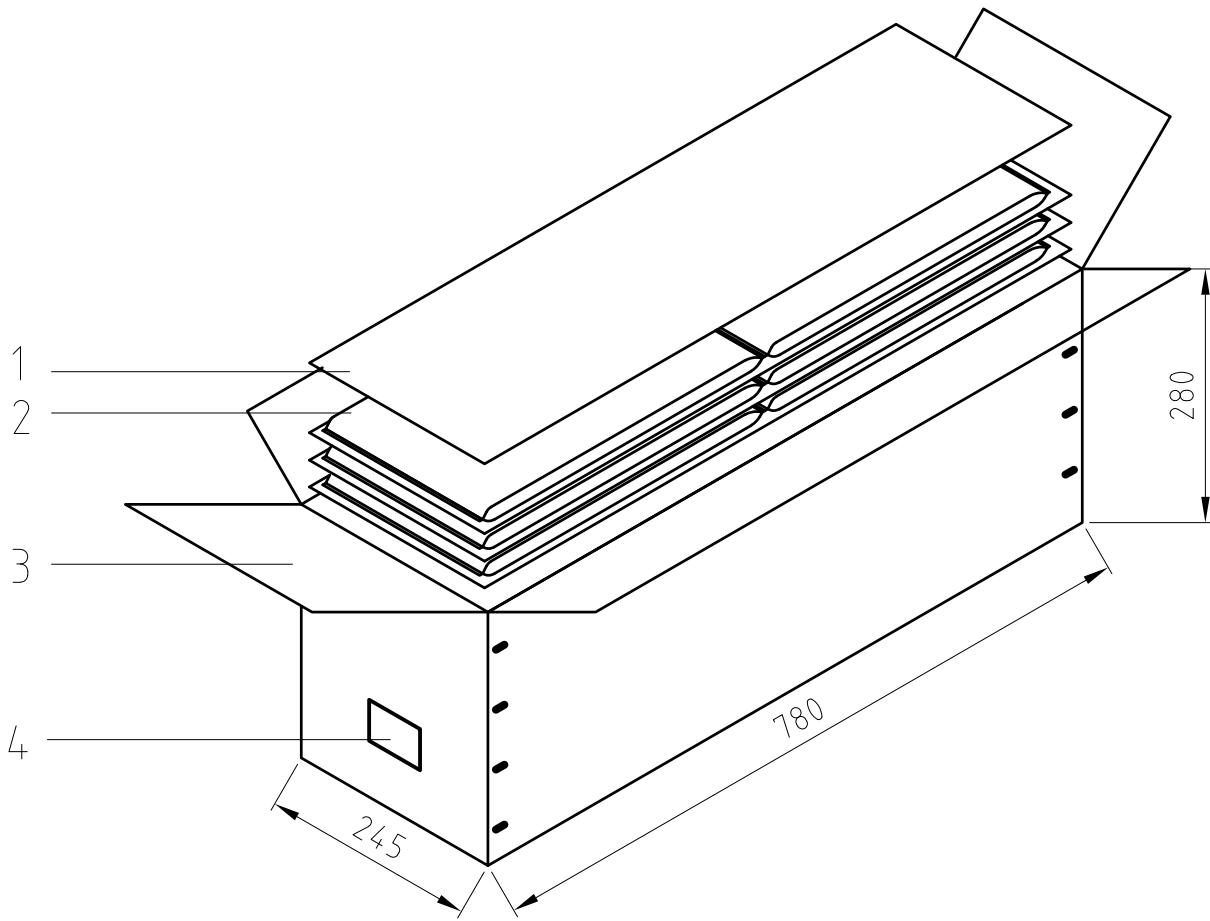

序号	详细信息
1	隔板
2	双层呼吸袋包装并封口的产品
3	五层瓦楞纸箱
4	纸箱标签

Tofflon 东富龙		此图纸版权属于东富龙所有，对未经许可擅自拷贝、使用者，本公司保留追究其法律责任的权利。 THIS DRAWING IS COPYRIGHT. IT MUST NOT BE COPIED, REPRODUCED OR OTHERWISE MADE USE OF WITHOUT THE TOFFLON'S WRITTEN PERMISSION.	
标题/TITLE: 托盘包装产品装箱示意图(6)		页/SHEET: 1 共/OF: 1	图幅/SIZE: A4_CN
客户名/CUSTOMER:		项目号/PROJECT NUMBER:	
设计/DESIGNED: ZX	日期/DATE: 2025.02.14	未注明公差表 TOLERANCED UNLESS OTHERWISE NOTED	
校核/CHECKED: WJY	日期/DATE: 2025.02.14	比例/SCALE: 2:25	
审核/APPROVED: MZ	日期/DATE: 2025.02.14	材料/MATERIAL: N/A	
		 MACHINING 机加工 GB/T 1804-m GB/T 1184-K	 WELDING 焊接 GB/T 19804-B GB/T 19804-F
			 SHEET METAL 钣金 GB/T 15055-m

1	2	3	4
版本	修订标记	修订说明	修订人

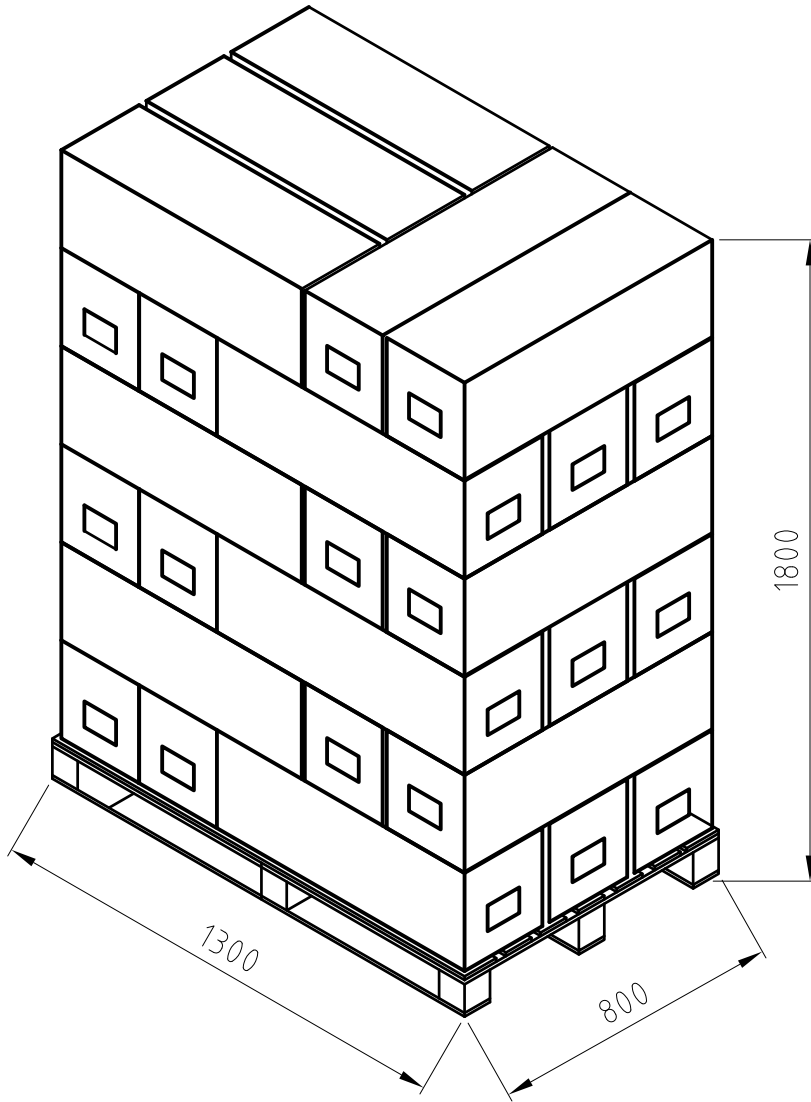

Tofflon 东富龙		此图纸版权属于东富龙所有，对未经许可擅自拷贝、使用者，本公司保留追究其法律责任的权利。 THIS DRAWING IS COPYRIGHT. IT MUST NOT BE COPIED, REPRODUCED OR OTHERWISE MADE USE OF WITHOUT THE TOFFLON'S WRITTEN PERMISSION.		
标题/TITLE: 托盘包装产品堆码示意图		页/SHEET: 1 共/OF: 1	图幅/SIZE: A4_CN	
客户名/CUSTOMER:		项目号/PROJECT NUMBER:		
设计/DESIGNED: ZX	日期/DATE: 2024.04.25	质量/MASS:	未注明公差表 TOLERANCED UNLESS OTHERWISE NOTED	
审核/CHECKED:	日期/DATE:	比例/SCALE: 1:20	MACHINING 机加工	WELDING 焊接
审核/APPROVED: SYT	日期/DATE: 2024.04.25	材料/MATERIAL: N/A	GB/T 1804-m GB/T 1184-K	SHEET METAL 钣金 GB/T 19804-B GB/T 19804-F
			GB/T 15055-m	